



MINI-PUMP 120

**Automatic Circulator
To increase water pressure**

Handbook

Index

| | |
|--|-------------------|
| Cautions | Pag. 01 |
| Description | Pag. 02 |
| Dimensional Data | Pag. 03 |
| Applications | Pag. 04 |
| Functions | Pag. 04 |
| Flow Control | Pag. 04 |
| Installation Cautions | Pag. 05/06 |
| Installation | Pag. 07/11 |
| Temperature | Pag. 12 |
| Pumping liquids | Pag. 13 |
| Curves | Pag. 13 |
| Problems Solving | Pag. 14 |
| Warranty | Pag. 15 |
| UE - Correct Disposal Of This Product | Pag. 16 |

Cautions

1. Read and understand this user manual before installation and operation of the product.
2. The warning sign marks notes whose non-observance will endanger your health or the functioning of the device.
3. The user has to rely on a qualified staff, able to fully understand the electrical regulations and this manual.
4. The pump should be installed in dry and ventilated area, away from water splashing, to avoid short circuit.
5. For easy maintenance, shut-off valves should be installed in both suction and discharge lines.
6. During installation and maintenance, we recommend to cut off the pump power supply.
7. It is strictly forbidden to start the pump without pumping liquid.
8. Always shut down the pump before touching or proceeding with any intervention on it. Allow all system and pump components to cool, before you handle them.
9. In the summer, or when there is very hot, please pay attention to ventilation; the condensation that may formed on the pump may cause electrical failures.
10. At low temperatures, we recommend to remove the liquid inside the pipelines to avoid cracking.
11. In the perspective of long periods of inactivity, make sure to close the inlet and outlet valves.
12. If the supply cord or the plug are damaged, please ask a qualified centre to replace them.
13. If you are unable to find a solution to a problem, or if the pump's temperature is greater than the value reported on nameplate; remove the power, disconnect the pump (through the valves put on the piping), and please contact your local dealer or service; or send an email to the following address:
support@xpowerwaterpumps.com
14. Keep out of reach of children.
15. Install the pump in a dry and well ventilated area.

Description

MINI-PUMP 120 is an automatic circulating pump with "Auto Start-Stop".

It is designed to increase water's pressure up to 1.2 Bar.

Thanks to the hydraulic conformation, you can dissect the pipe and install MINI-PUMP in small spaces.

The pump has horizontal inlet and outlet. In fact, it is possible to divide the pipe (as long as you respect the direction of the flow indicated on the pump).

MINI-PUMP 120 is equipped with a system that adjusts the Start in function of the water extraction.

The pump starts automatically when water is utilized and operates continuously until water is no longer required and is turned off.

MINI-PUMP 120 can pump clean liquid (with temperature between +2 °C and +90 °C), free of solids.

Each X-POWER product is always accompanied by a manual:

The manual indicates to the possible dangers arising from the misuse of the machine.

It suggests possible precautions.

It suggests possible solutions for any failure and/or anomalies that may occur.

The retailer declines responsibility for damage resulting from unauthorised modifications.

Dimensional Data

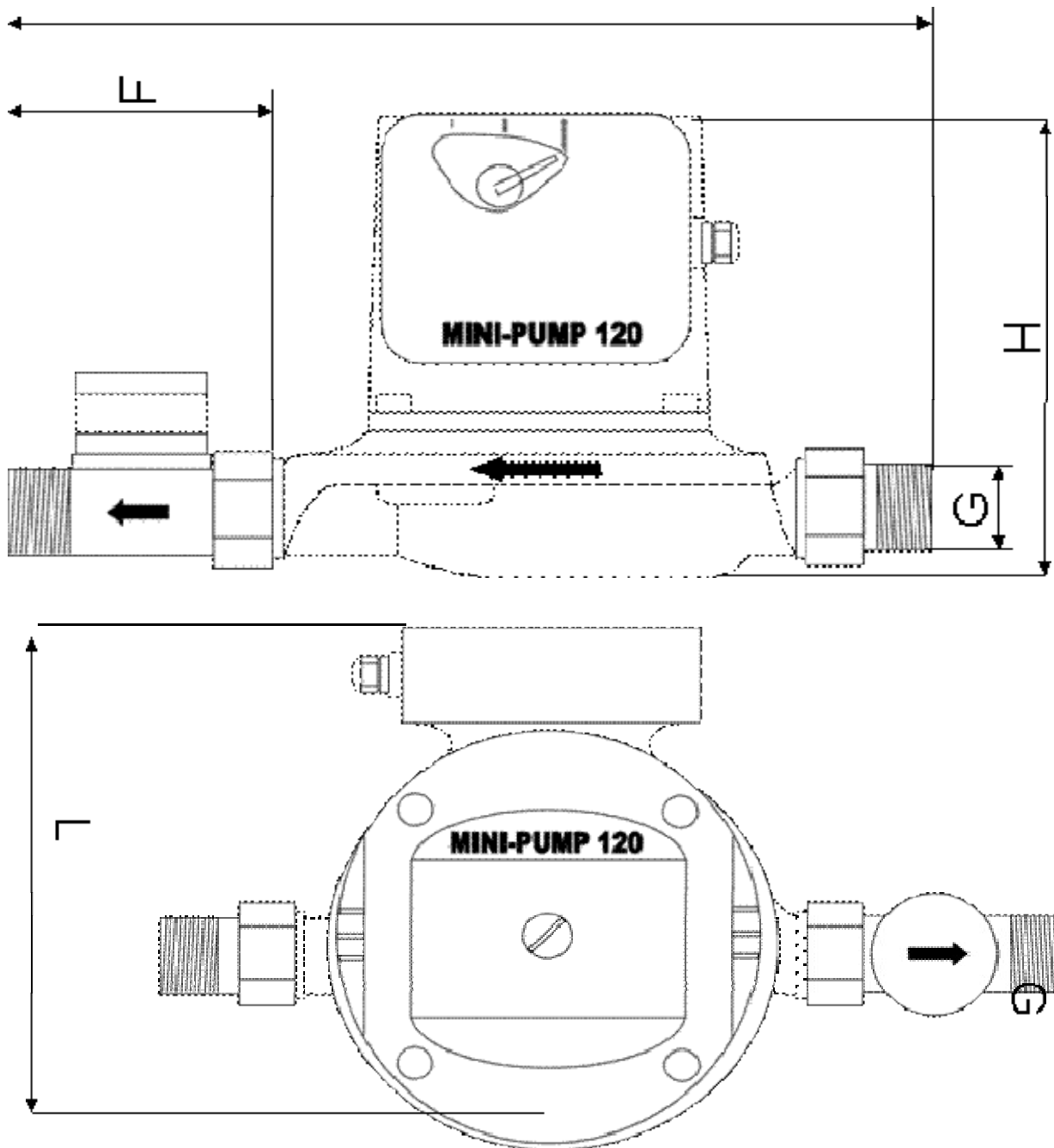

| MINI-PUMP 120 Dimensional Data | | | | | |
|-----------------------------------|-----------|-----------|-----------|------|----|
| F (mm) | H (mm) | I (mm) | L (mm) | G | G1 |
| 80 | 150 | 255 | 150 | 3/4" | 1" |



Applications

The circulating pump increase the pressure of liquids, that have a temperature between +2 °C and +90 °C.

You can connect MINIPUMP:

- 1) directly to the pipe,
- 2) directly to the tank,
- 3) directly to the boiler (cold water).

Functions

| | | |
|----------------------|-----|--|
| Reduced speed | I |  |
| | | |
| Average speed | II |  |
| | | |
| Full speed | III |  |
| | | |

Flow Control

MINI-PUMP is characterized by an external static flow switch, that must be perfectly clean.

It is strongly advised to install a filter that can remove impurities carried by water, to avoid locks of mechanisms or loss of precision.



Installation Cautions

1. Run the pump only after verifying the absence of impurities or suspended solids inside the pipes. Impurities must be removed before performing.
2. Make sure that the supply voltage is compatible with the voltage reported on the pump's label.
3. The installation site must be freely accessible for installation and maintenance.
4. Make sure that MINI-PUMP is always installed with the axis horizontally, respecting the flow direction.
5. The MINI-PUMP requires no special maintenance, except in winter: with temperatures near freezing, you have to empty the pipeline to prevent cracks in the machine.
6. Screw the MINI-PUMP to the suction and discharge pipes, only using required sealants and/or required seals.
7. After a long period of inactivity, check the operation of the circulating pump. In case of blocking, turn off the electricity, close the inlet valve and unlock the pump via the screw on the back.
8. We recommend to use a repairs switch, that disconnects the power supply poles.
9. The network and relative outlets must be fitted with an efficient earthing connection following the laws in force on the matter of electrical systems.
10. Periodically check the MINI-PUMP resistance.
11. Electrical cables and components must be in accordance with good engineering practice in relation to safety.
12. In the case of electrical parts damaged and/or anomalies, contact the service centre or send an email to: support@xpowerwaterpumps.com

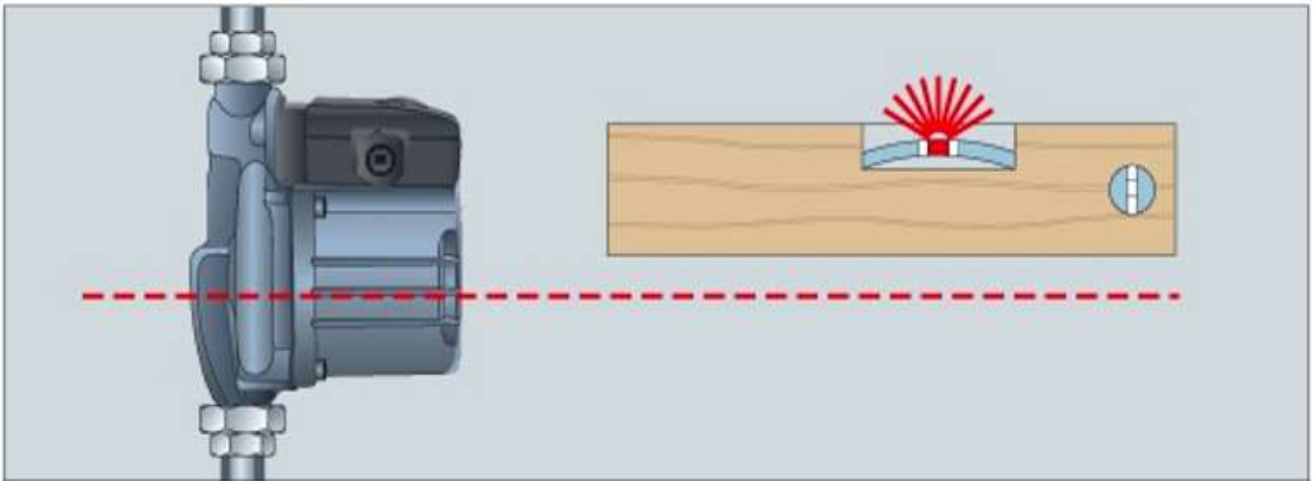

▼ **Correct installation**

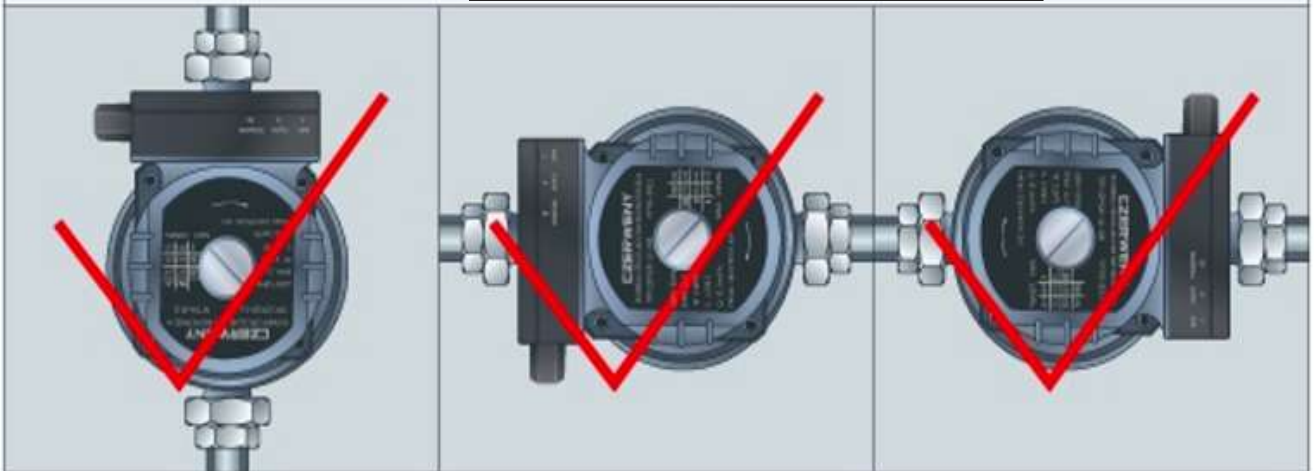

▼ **Incorrect installation**

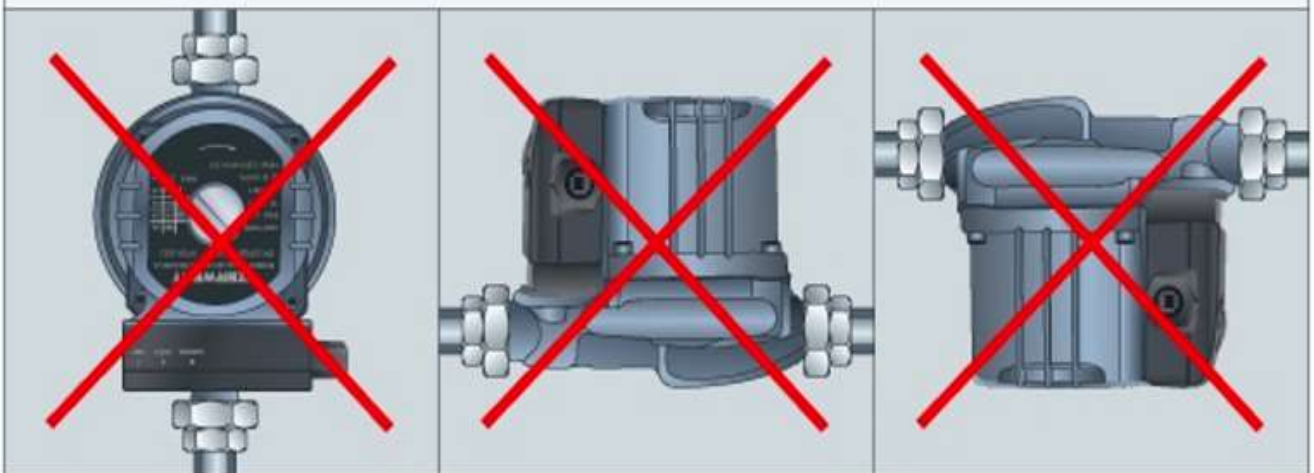



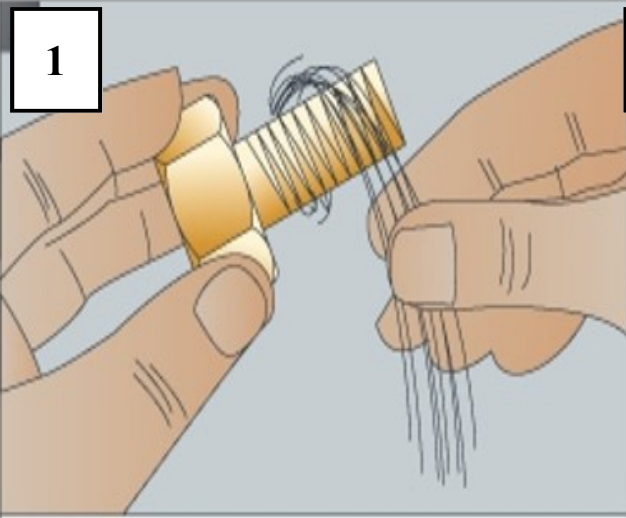
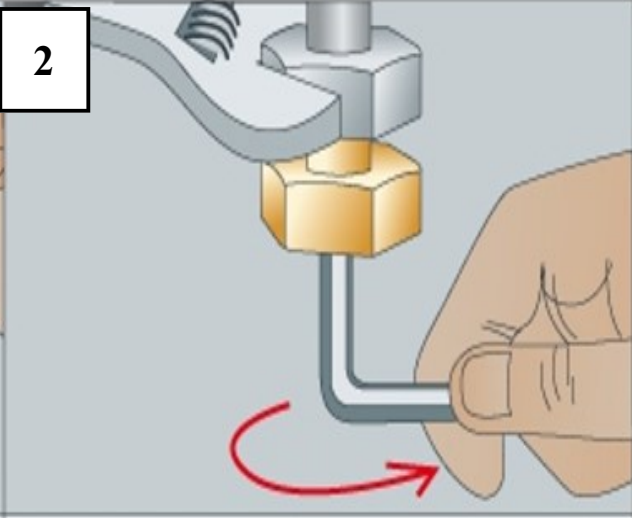
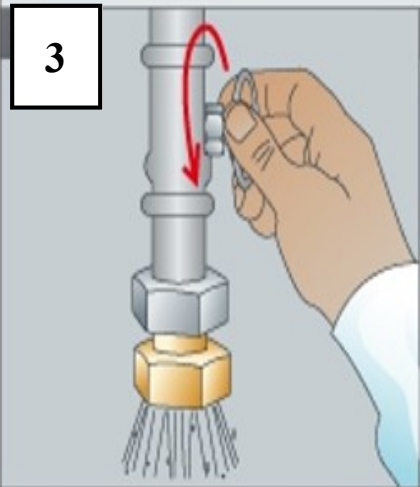
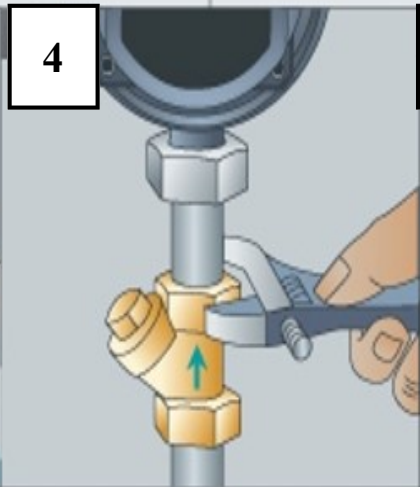
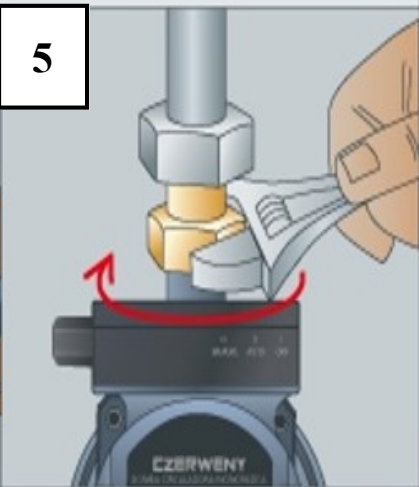
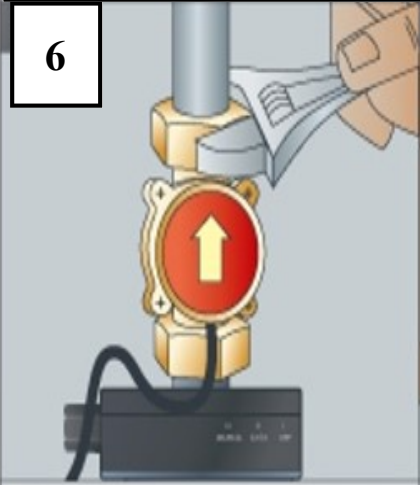
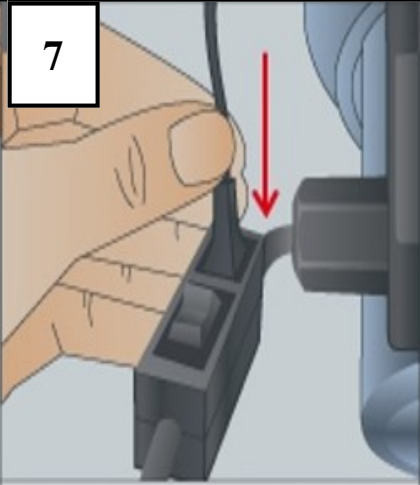
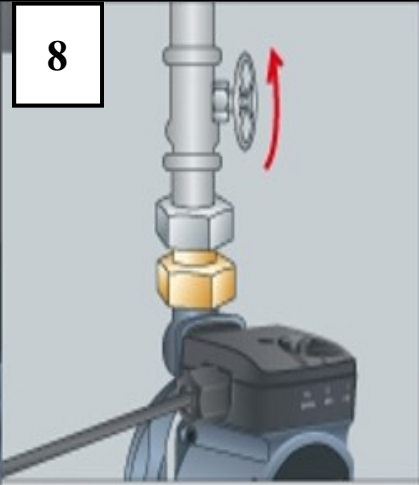

Installation

| | | |
|--|--|---|
|  <p>1</p> |  <p>2</p> | |
| <p>Use a Teflon tape</p> | <p>Make the pipe secure</p> | |
|  <p>3</p> |  <p>4</p> |  <p>5</p> |
| <p>Check the water clarity</p> | <p>We recommend the use of an input filter</p> | <p>Connect MINI-PUMP</p> |
|  <p>6</p> |  <p>7</p> |  <p>8</p> |
| <p>Installl the flow switch in the delivery pipe</p> | <p>Insert the connector to MINI-PUMP</p> | <p>Open the valves</p> |

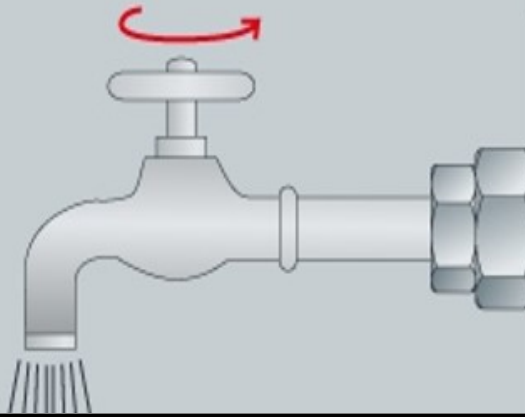
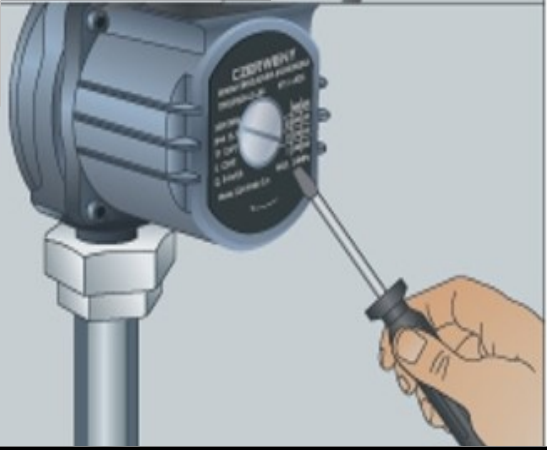

In order to ensure best performance, it is absolutely essential to allow air to escape before installing MINI-PUMP

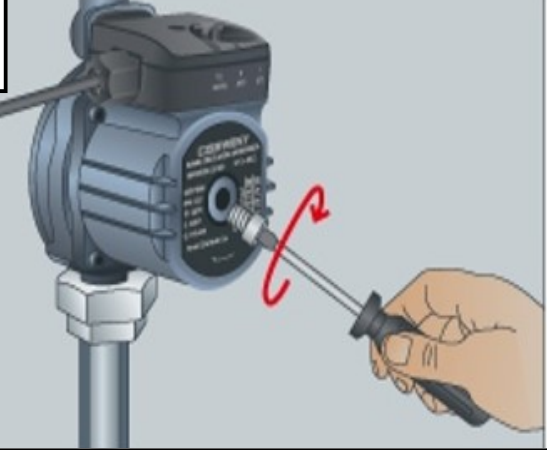
| | |
|---|--|
| A  | B  MINI-PUMP |
| Connect the pump to the mains | Switch the device selector (2) in Automatic mode (position I) |
| C  | D  |
| Open a faucet | Loosen the bleeder screw |
| E  | F  |
| Allowing the air outlet | Place the screw |

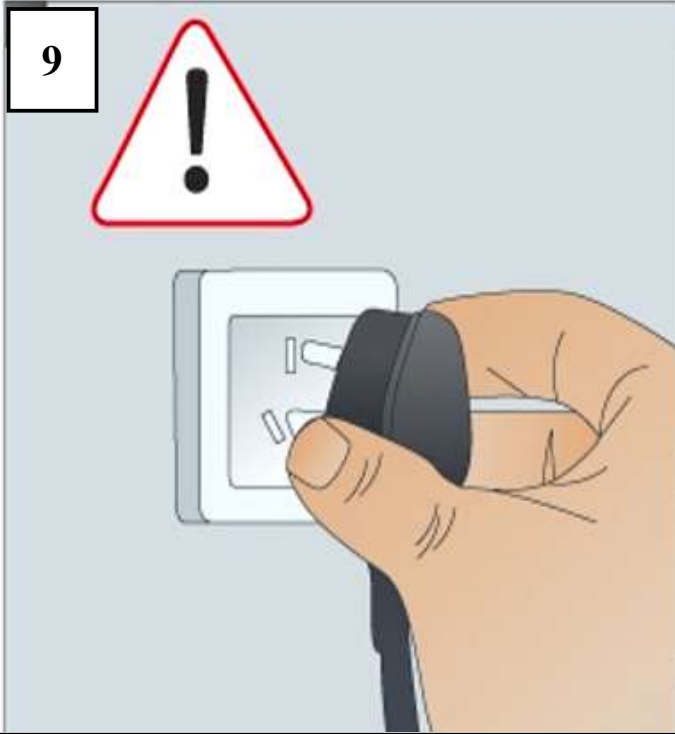

9

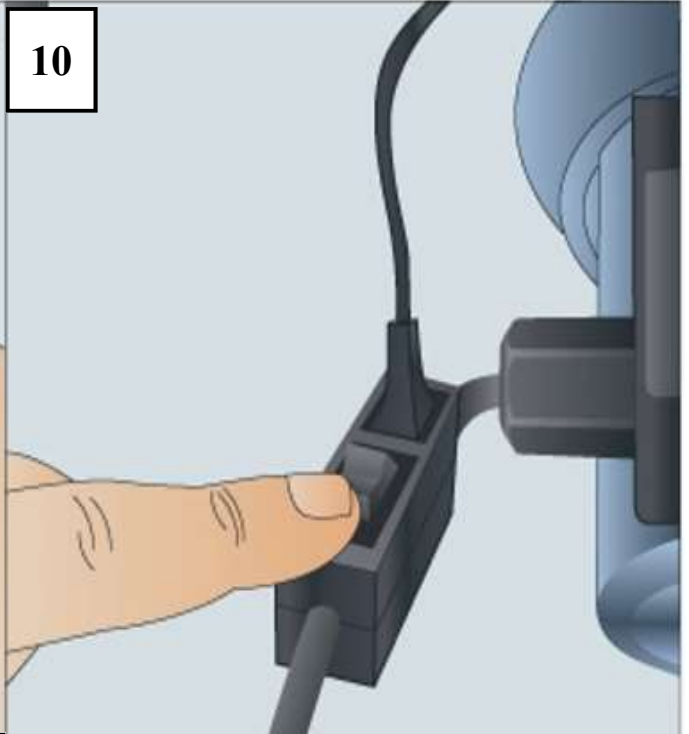

10

**Insert the plug into the electrical outlet
(Make sure that electrical outlet is properly grounded)**

Switch to automatic mode (I)

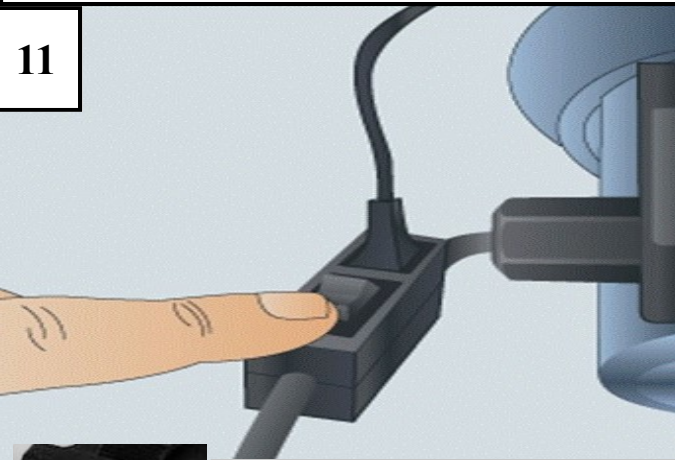

11



12



**I: Automatic
O: OFF
II: Manual**

Move the device selector (located in the box) to the desired speed (I - II - III)

- It is strongly recommended to install an automatic air vent valve, upstream of the pump, to enable better performances.
- Do not install the MINI-PUMP in the outlet pipe of the boiler.

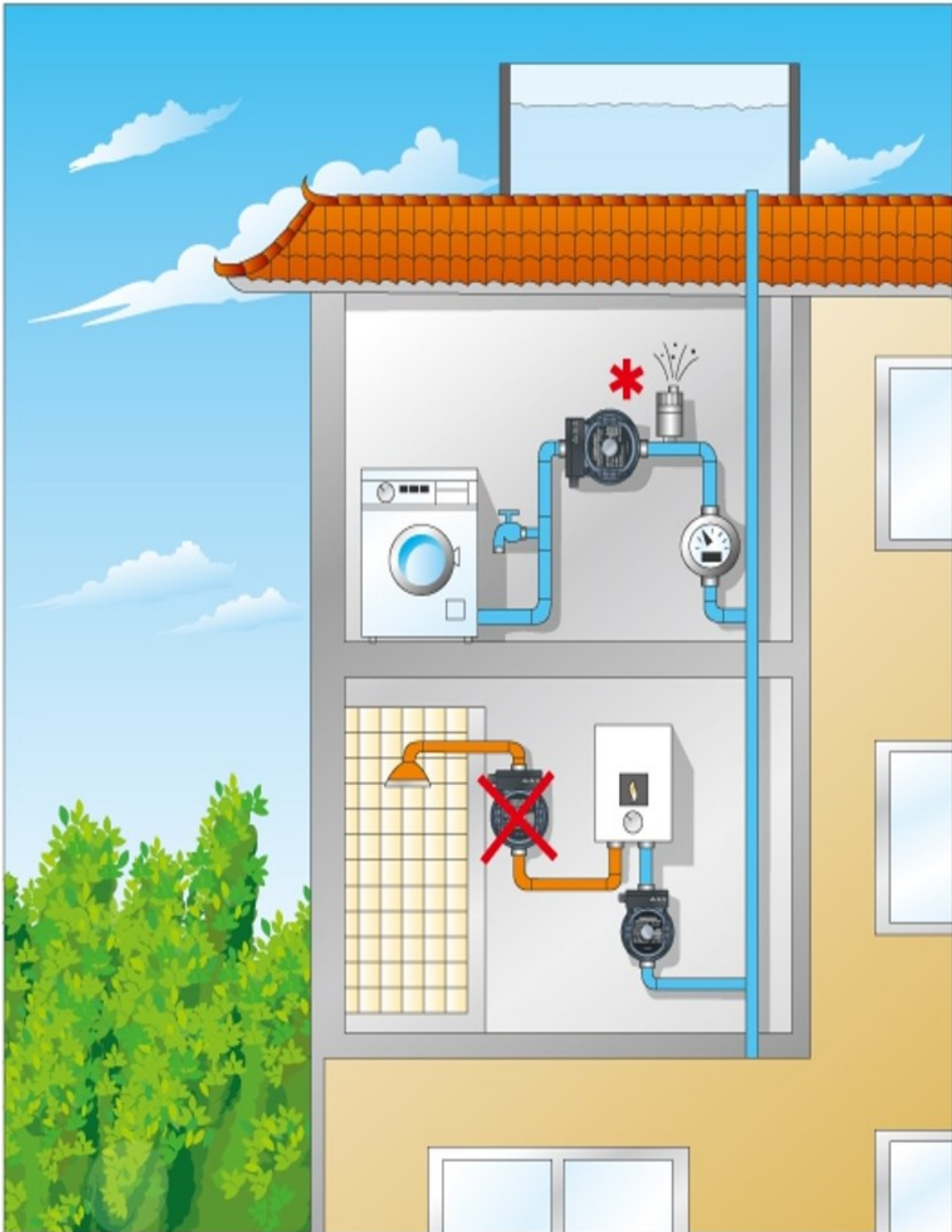

- You can install MINI-PUMP both inside and outside the house; provided that it is a dry site, protected from bad weather and low temperatures.
- Avoid installation in humid sites where condensation may damage the pump.

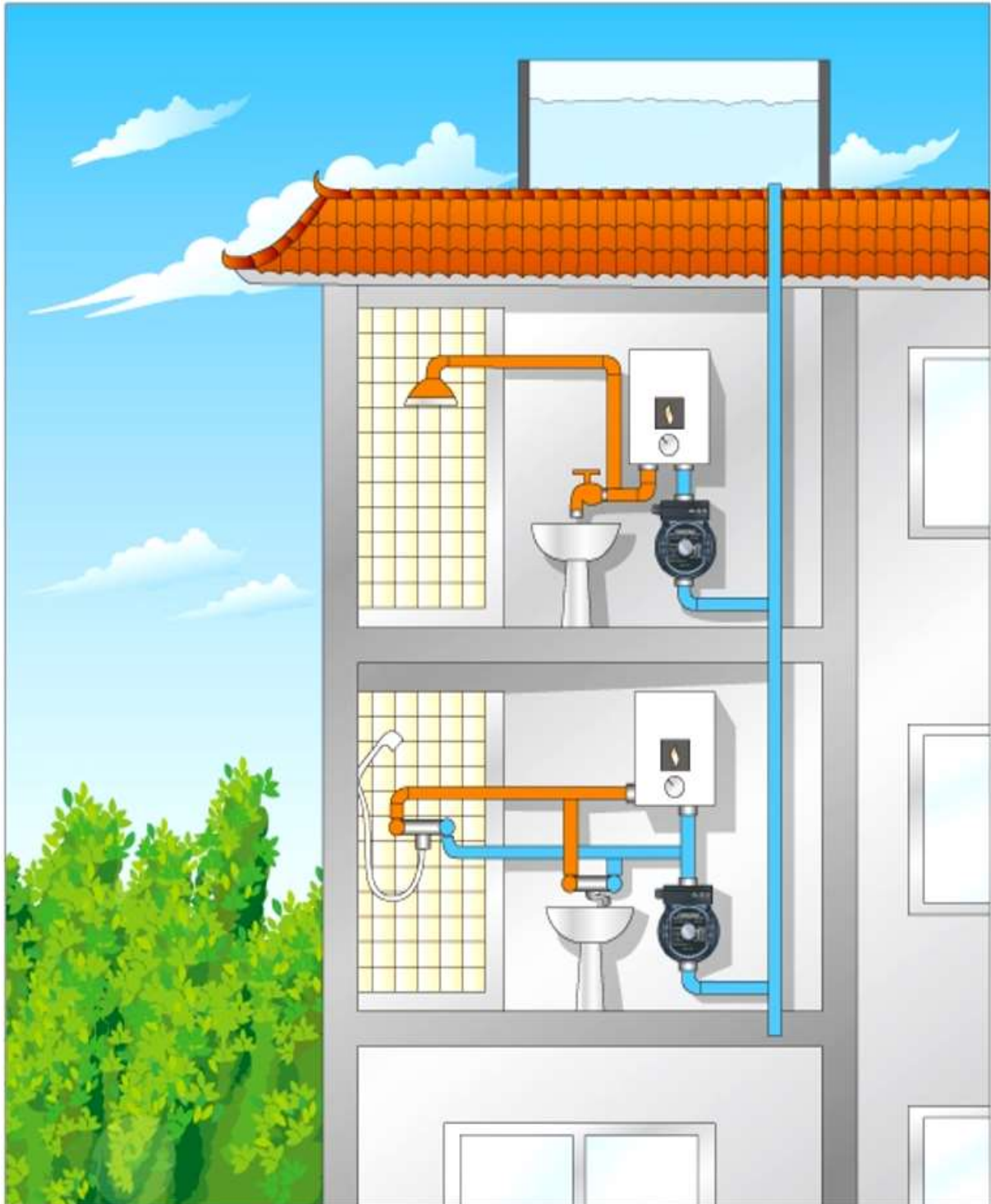

Temperature

The "system temperature" (t1) must be higher than the "environment temperature" (t2), in order to avoid excessive condensation on the pump housing.



Condensation can cause short circuits!

System Temperature (t1)

**Max Liquid Temp: +90 °C
Min Liquid Temp: +2 °C**

Ambient Temperature (t2)

**Max Ambient Temp: +40 °C
Min Ambient Temp: +2 °C**

**220-240V
50Hz
IP 44
TF +90 °C
Q max 58 cu.m /h
H max:12m
max 1.0MPa**

Pumping liquids

The pumped liquid must be clean, free from impurities and non-corrosive.

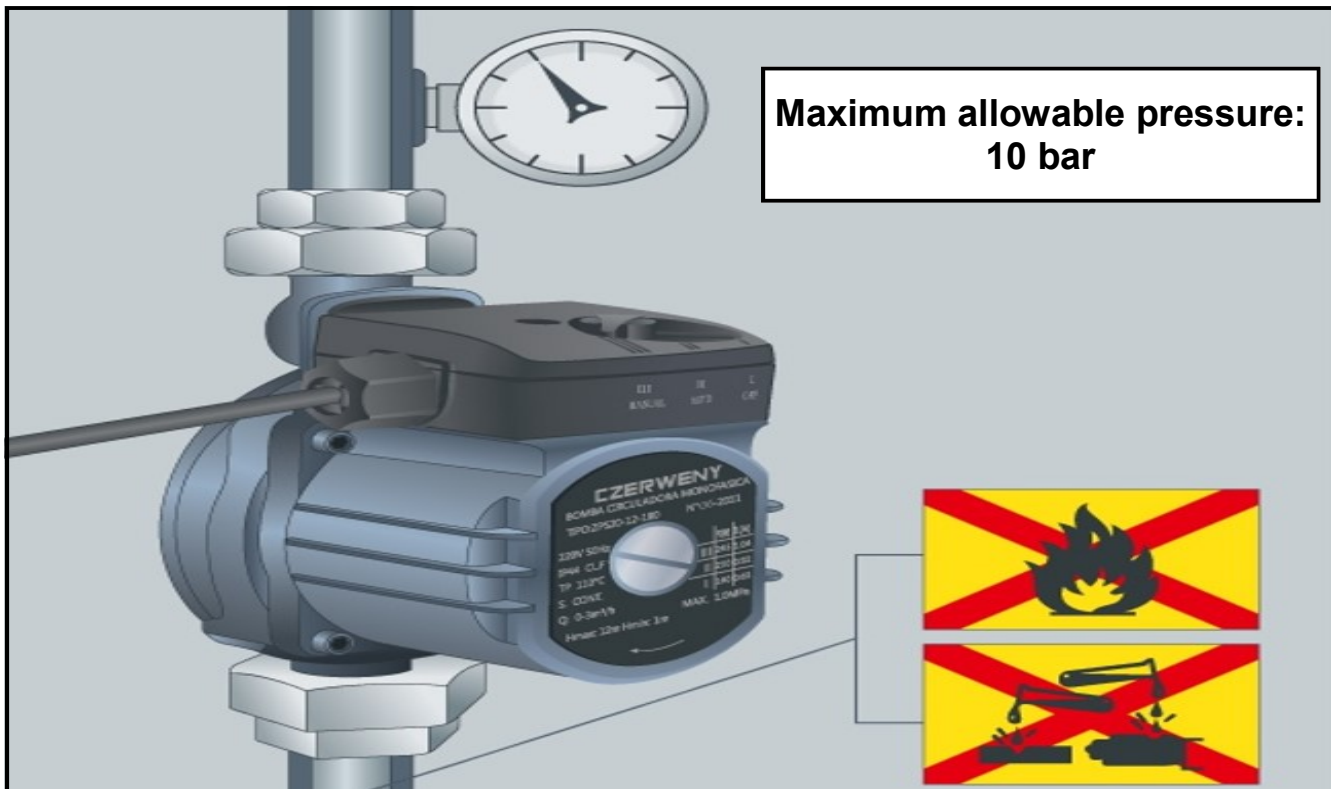

When MINI-PUMP 120 works in automatic, the liquid pressure in the input must not fall below 0.5 bar; pressure downs, can cause cavitation to MINI-PUMP 120.

Curves

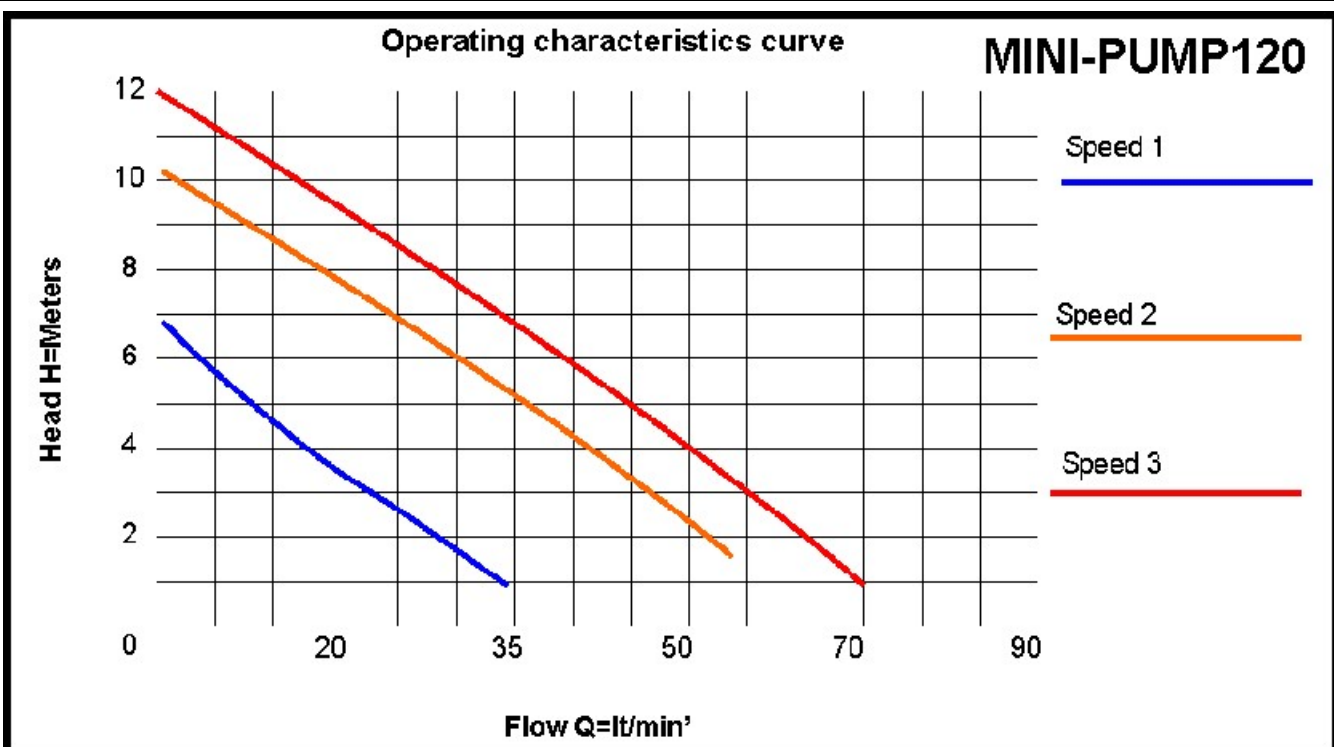

Problems Solving

| Problem | Cause | Solution |
|---|---------------------------------|--|
| MINI-PUMP does not start | The switch is off | Slide the switch to Manual or Automatic |
| | Electric problem | Check if the power supply works |
| | Dirty flow switch | Clean the flow switch |
| Excessive noise | Air in the pump | Bleed all the air in the circuit |
| The pump does not stop despite water and sanitary system closed | It is set to manual mode | Slide the switch to Automatic |
| | Dirty flow switch | Clean the flow switch |
| The pump works but does not pressurizes | The valve is closed | Open the valve |
| | Air in the pump | Disconnect the pump for a few minutes and open a tap to remove the air from the pipeline |
| | Dirty pump or dirty flow switch | Dismantle the pump and the flow switch. Perform cleaning and reassembly. |

The pump can malfunction as a result of presence of impurities in the flow switch. In this case, please contact qualified personnel authorised to resolve the problem.

In the event of a fault on the pump, it is necessary intercede with the following steps:

1. Turn off power to the pump.
2. Close the water inlet and outlet.
3. Unscrew the 4 screws of the flow switch.
4. Thoroughly clean the internal components.
5. Reassemble the flow switch respecting the flow direction.

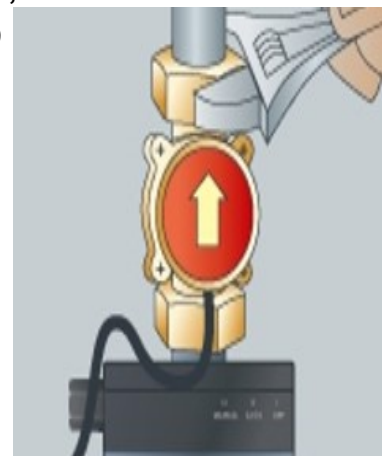

MINI-PUMP 120 Warranty certificate

Thank you for purchasing this pump, that is designed and manufactured to exacting high standards, and to confer safety and high quality performance. The legal guarantee starts from the date of purchase and does not cover damage caused by improper use and/or tampering not expressly indicated in this manual.

For warranty, fill out the following form.

Model

Number

Invoice numb. or receipt (staple here the sales receipt)

Date of purchase

Place of purchase

Problem

UE - Correct Disposal Of This Product



This symbol identifies important notes regarding the correct disposal of the device.

By disposing of this product correctly you will help ensure that the waste undergoes the necessary treatment, recovery and recycling, and thus prevent potential negative effects on the environment and human health which could otherwise arise due to inappropriate waste handling. For more information concerning the correct disposal of these products, please contact your reseller.

CE DECLARATION OF CONFORMITY

Elettromek enterprise of Germanò Antonino
Via C. Colombo - 98066 Patti, Messina, Italy

As attestation of the manufacturer,

DECLARES THAT

The following model:

MINIPUMP120

It is conform to the Standard:

EN ISO 12100:2010, EN 809:1998+A1:2009+AC:2010,
EN 60204-1:2006+A1:2009+AC:2010,
EN 60335-1:2012+AC:2014, EN 62233:2008+AC:2008,
EN 60335-2-41:2003+A1:2004+A2:2010,
EN 60034-1:2010+AC:2010,
EN 55014-1:2006+A1:2009+A2:2011,
EN 55014-2:1997+A1:2001+A2:2008,
EN 61000-3-2:2014, EN 61000-3-3:2013

Complying with EC Directives:

2006/42/EC (Machinery)
2014/35/EU (Low Voltage)
2014/30/EU (Electromagnetic

Patti (ME) Italy
Germanò Antonino

www.xpowerwaterpumps.com